

VIN : 5V

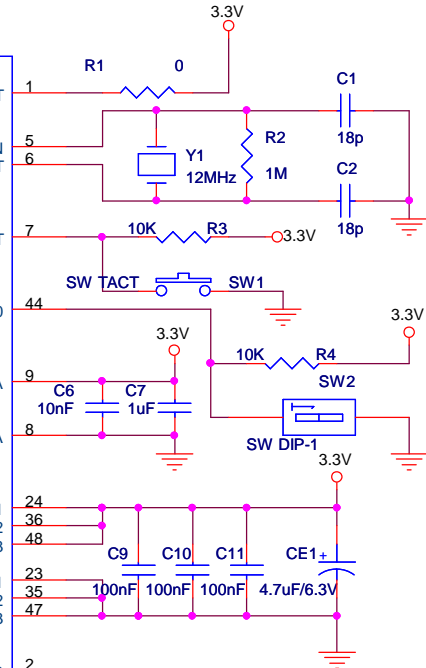
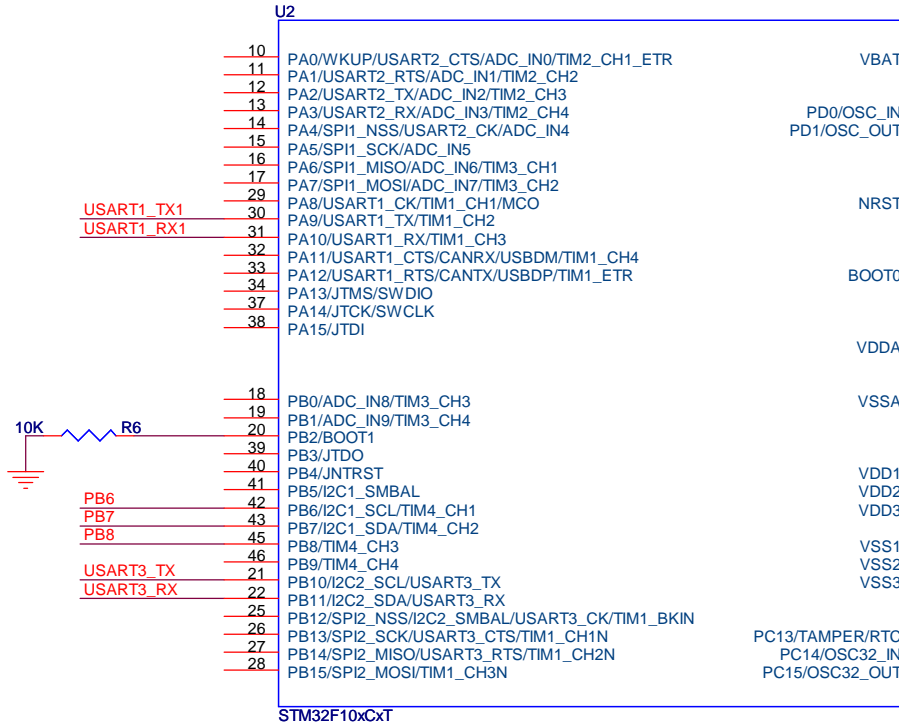
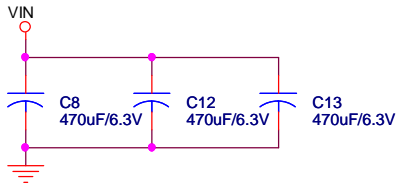
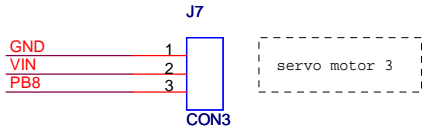
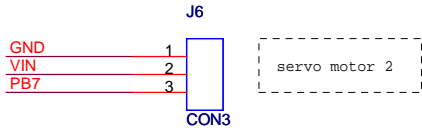
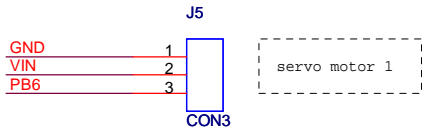
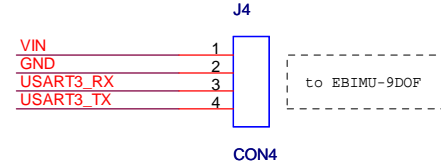
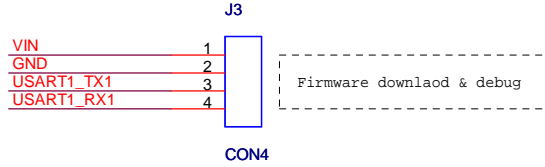
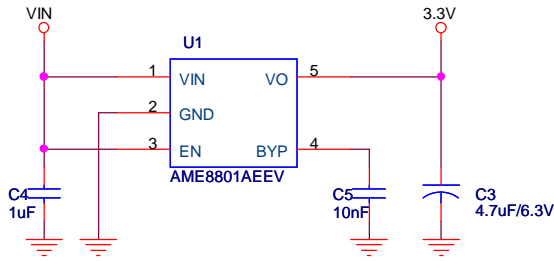

* DIP S/W *
 ON : User Flash Memory
 OFF : System Memory(Boot Loader)

4.7uF capacitor must be connected to VDD3

Title		
SERVO		
Size	Document Number	Rev
A4	E2BOX	v1.0
Date:	Monday, April 16, 2012	Sheet 1 of 2